

InteDolphin

Choose us

Customized kitchen cabinet has different styles. In order to better match their own home space and meet their own needs, most consumers are more inclined to purchase customized kitchen cabinet. Its style and various functions are both an expression of the owner's attitude towards his life and a highlight of home decoration.



Island

From dining to dish storage to comfy seating, islands are for much more than preparing food these days. No matter your needs or the size of your kitchen, there's an island for you.



Our design

Maximizing your available kitchen cabinets storage space with add-on parts and accessories should be a primary goal for your kitchen remodel.

Your kitchen, your way

Looking for an easy refresh? PA Furniture gives you the freedom to create a flexible bedroom that is easy to assemble and customize for life's many changing phases - or when you just want to show a little more of your personality.



Door color: BK109

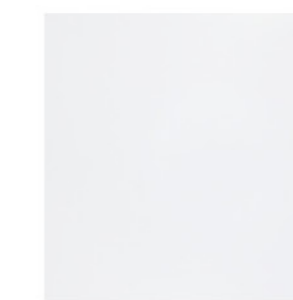

Door color: BK118



Door panel material

Lacquer painting kitchen cabinetry, with its incomparable strong visual impact and unique design style, is more and more popular with people.

Why choose

adheres to the service concept and business philosophy of "customer first" and "people-oriented", and customizes comfortable and warm home furnishing products for customers.

design

We can not only make regular designs, we also make special customization according to customer's requirements, our purpose is to fully meet with our customer's needs.

Door panel material

The glass door is matched with the plain color door, which is clean and shows large space, and the whole kitchen is more atmospheric.



Choose us

Customized kitchen cabinet has different styles. In order to better match their own home space and meet their own needs, most consumers are more inclined to purchase customized kitchen cabinet. Its style and various functions are both an expression of the owner's attitude towards his life and a highlight of home decoration.



Choose your style

Uses the door panels of different colors to follow the lines smoothly, which perfectly interprets the design concept of the perfect balance between function and design.

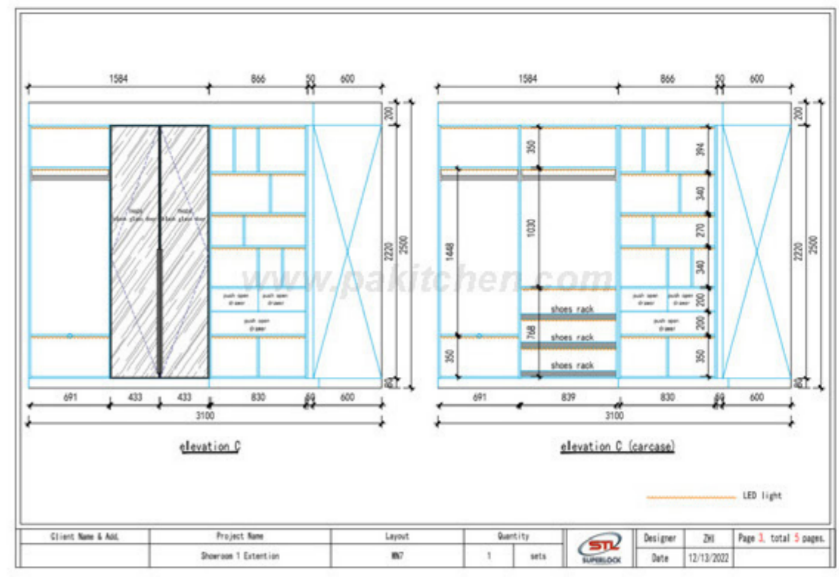

Why do everyone choose whole-house customization?

Customized furniture not only meets consumers personalized aesthetic needs, but also has more personalized functions.

Opening kitchen cabinets: the color matching of Metallic color lacquer and UV bar counter, looks homely and warm impact.



Door color: Y503

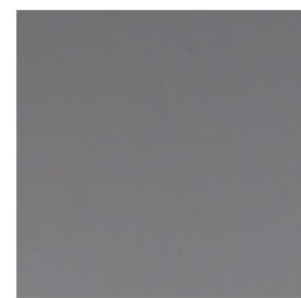

Door color: L3138

Best design

Our best kitchen designs will give you inspiration for your own kitchen makeover.

Whatever layout you have, these kitchen decorating ideas will help you remodel your kitchen and features for style, function and flair in the heart of your home.

Choose us

whole house customization, change your life, customize it.

Custom-made cabinets

Customization is Personalization: When kitchen cabinets are to be customized, it is easier to design them around the personal stuff you have such as the size of appliances, equipment or even the kind of dinnerware.

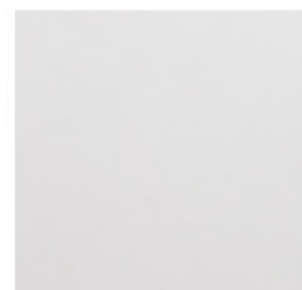

Door color: L3101



Door color: L3102



Why choose us

is easier to accommodate the specific preferences of a customer such as deeper drawers for larger utensils, larger bins or even the storage area that is to be allocated. Thus, customization leaves behind a touch of personalization.



Door color: Y29



Door color: Y88

Why choose

Customized cabinets have quickly become one of the most popular cabinet styles for kitchens of every type.

The simple, square-paneled doors look flawless with any hardware.





Choose your style

Uses the door panels of different colors to follow the lines smoothly, which perfectly interprets the design concept of the perfect balance between function and design.



Your room, your way

Customized has different styles. In order to better match their own home space and meet their own needs, most consumers are more inclined to purchase full house customized.

You might be surprised by how much new countertops impact kitchen designs. For example, this Melamine and lacquer is beautiful enough to serve as a focal point for your entire kitchen.



Door color: Y29





Barthroom cabinet

Whether you're looking at a full bathroom remodel or just a quick update, choosing a vanity in a bold color is a great way to make a dramatic statement without breaking the bank.



Door color: Y29



Door color: Y88

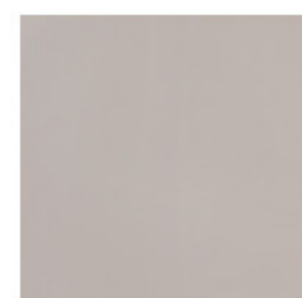

Door color: Y117

A shared place, your own space

Calm and coordinated furniture series is a stylish way to streamline your shared sanctuary with the rest of your home. Both open and closed storage lets you enjoy a classic atmosphere that's filled with a sense of well-being



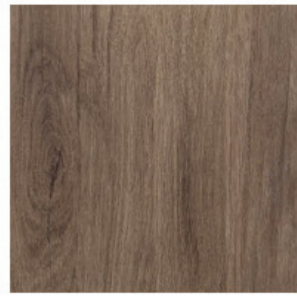

Door color: Y201



Why choose

At every stage of production we combine manual skills and modern technology. All our departments are modernly organized and structured.

Stylish comfortable

Keeping a small kitchen calm and tidy can be easier than you think.

Organize a mesmerizing, functional space with good storage, mood-setting lights and dark colors - and stay true to your minimalist soul. Regardless of the size of your room, a kitchen cabinet the spaciousness that makes a difference, too.

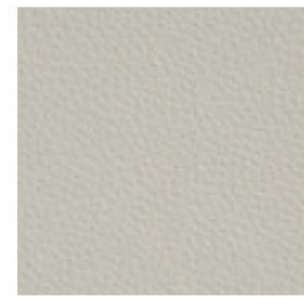

Door color: Y123



Door color: Y88



Why choose

We are one of the top ten cabinet brands and one of the world's leading factories. We have received recognition and praise from customers all over the world, which is what we are always do!









In the manufacturing sites skilled workmen control the last most updated generation of CNC Machines. The heart of design: aesthetic, elegance and experience, stay for reliable products, new images for future bathroom but remaining a still conscious witness of past traditions.

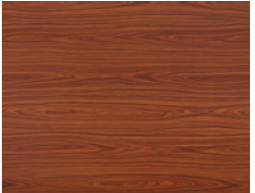

Customization is the spirit of modernness translated in a flexible design where every requirement finds its expression. Research and innovation is reflected in a wide sample set of over two hundred different finishes: an harmony of selected materials for a trendy interior design project.

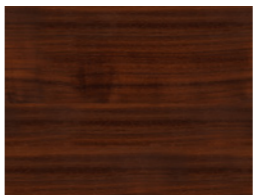
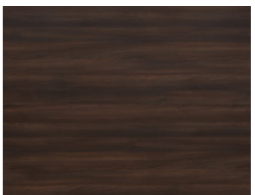
MATERIAL INFO

				
SW001#	SW002#	SW003#	SW004#	SW005#
				
SW006#	SW007#	SW008#	SW009#	SW010#
				
SW011#	SW012#	SW013#	SW014#	SW015#



77-48-TB
 Size : 48" x 22" x 35.4"

77-36-TB

Size : 36" x 22" x 35.4"

Each drop of water waving in the wind seems to be the innovating inspiration flowing under the baton. The modern sanitary wares grow up with living art, each drop is the leaping note in the perfect movement.



77-60-TB

Size : 60" x 22" x 35.4"





78-60-DB
Size : 60" x 22" x 35.4"

Simplicity and simplicity are both an attitude towards life. Let our city have a more concise, quiet and fresher attitude to life.



78-48-DB
Size : 48" x 22" x 35.4"



78-36-DB
Size : 36" x 22" x 35.4"



69-60-DB
 Size : 60" x 22" x 35.4"





69-30-DB
Size : 30" x 22" x 35.4"



69-36-DB
Size : 36" x 22" x 35.4"



69-48S-DB
Size : 48" x 22" x 35.4"



69-48D-DB
Size : 48" x 22" x 35.4"



10-48D-WH
Size : 48" x 22" x 35.4"



10-60-WH
Size : 60" x 22" x 35.4"



10-48S-WH
Size : 48" x 22" x 35.4"



10-36-WH
Size : 36" x 22" x 35.4"



66-60-TB
Size : 60" x 22" x 35.4"



66-48D-TB
 Size : 48" x 22" x 35.4"



66-36-TB
 Size : 36" x 22" x 35.4"



66-30-TB
 Size : 30" x 22" x 35.4"



66-48S-TB
 Size : 48" x 22" x 35.4"



55-60-TB
Size : 60" x 22" x 35.4"



55-48D-TB
Size : 48" x 22" x 35.4"



55-48S-TB
Size : 48" x 22" x 35.4"



55-36-TB
Size : 36" x 22" x 35.4"



33-36-NW
Size : 36" x 22" x 33"



33-48-NW
Size : 48" x 22" x 33"



22-60-DB
 Size : 60" x 22" x 35.4"



22-48S-DB
 Size : 48" x 22" x 35.4"



22-48D-DB
 Size : 48" x 22" x 35.4"



22-36-DB
 Size : 36" x 22" x 35.4"



22-30-DB
 Size : 30" x 22" x 35.4"



20-60-WH
Size : 60" x 22" x 35.4"



20-60-GR
Size : 60" x 22" x 35.4"



20-48-WH
Size : 48" x 22" x 35.4"



20-36-WH
Size : 36" x 22" x 35.4"



20-48-GR
Size : 48" x 22" x 35.4"



20-36-GR
Size : 36" x 22" x 35.4"





FEATURES

- Anti-jump system
- Max.72" width for an open and spacious feeling
- Stainless steel rollers create an effortless operation
- Rubber door stopper protects the glass door
- SGCC certified tempered glass, 5/16"(8mm) & 3/8"(10mm)
- The anti-slash threshold in L shape to prevent water spills

Door Opening Direction

Two sliding door opening either left or right

Adjustment

Wall mount bracket solution: no out-of-plumb adjustment

Glass Option

Clear, Frost, Easy-Cleaning

Finish

Bright chrome, brushed nickel, black



A	Design options	Diagram	B	Design options	Diagram
Standard	Wall Mount Bracket		Standard	Handle	
Option	Wall Profile		Option	Clamp	

SPECIFICATION

Dimensions In Imperial Units

Model	Finish wall to finish wall (L)	Approx. entry opening(O)	Height (H)
3386	46"-48"	21"	60" 76"
	52"-54"	24"	
	57"-60"	27"	
	62"-66"	30"	
	66"-72"	32"	
Glass: 5/16" or 3/8"		Return panel(W):32"-36"	

Dimensions In Metric Units

Model	Finish wall to finish wall (L)	Approx. entry opening(O)	Height (H)
3386	1150-1200mm	529mm	1500mm 2000mm
	1200-1300mm	566mm	
	1300-1400mm	616mm	
	1400-1500mm	666mm	
	1500-1600mm	716mm	
	1600-1800mm	791mm	
Glass: 8mm or 10mm		Return panel(W):800mm , 900mm , 1000mm	

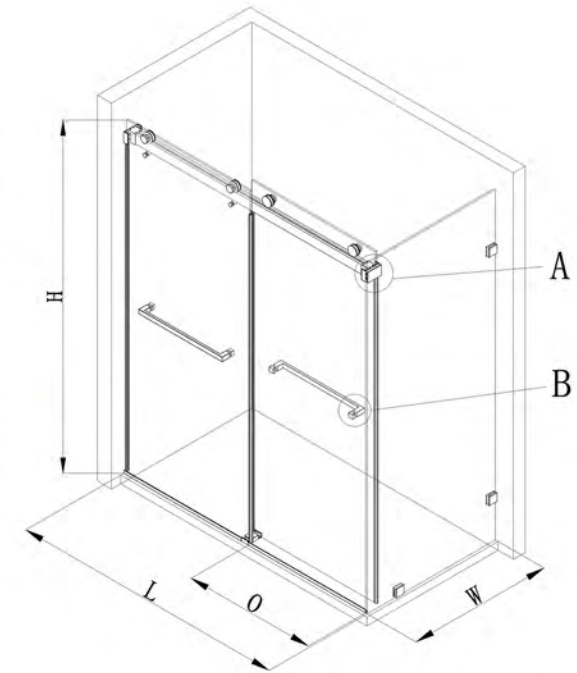

FEATURES

- Anti-jump system
- Max.72" width for an open and spacious feeling
- Stainless steel rollers create an effortless operation
- Rubber door stopper protects the glass door
- SGCC certified tempered glass, 1/4"(6mm)
- The anti-slash threshold in L shape to prevent water spills

Door Opening Direction

One sliding door opening either left or right

Adjustment

Wall mount bracket solution: no out-of-plumb adjustment

Glass Option

Clear, Frost, Easy-Cleaning, Black silk

Finish

Bright chrome, brushed nickel, black



A	Design options	Diagram	B	Design options	Diagram
Standard	Running track		Standard	Handle	
Option	Glass Profile		Option	Wall Profile	

SPECIFICATION

Dimensions In Imperial Units

Model	Finish wall to finish wall (L)	Approx. entry opening(O)	Height (H)
3390	46"-48"	20"	60" 76"
	52"-54"	23"	
	57"-60"	26"	
	62"-66"	29"	
	66"-72"	31"	
Glass: 1/4"		Return panel(W):32"-36"	

Dimensions In Metric Units

Model	Finish wall to finish wall (L)	Approx. entry opening(O)	Height (H)
3390	1150-1200mm	501mm	1500mm 2000mm
	1200-1300mm	539mm	
	1300-1400mm	589mm	
	1400-1500mm	639mm	
	1500-1600mm	689mm	
	1600-1800mm	764mm	
Glass: 6mm		Return panel(W):800mm , 900mm , 1000mm	

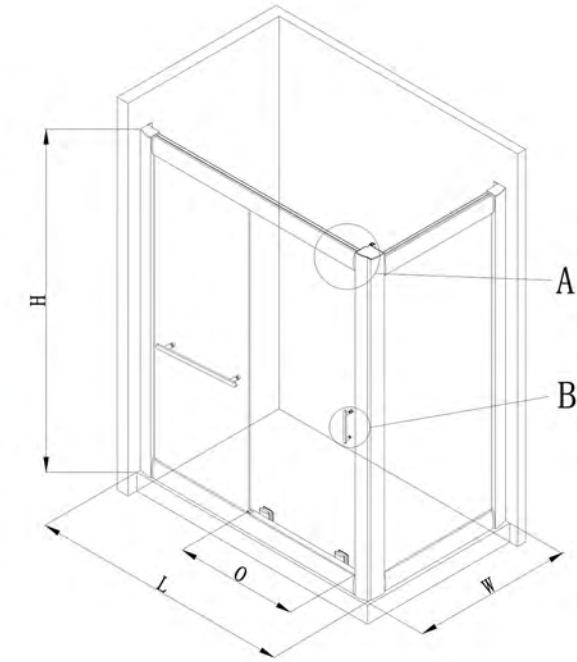

ADVANTAGE INTRODUCE

1. High quality 1/4" thickness tempered glass, which has passed the American certification can be clear or with decorative pattern.
2. It adopts 6463-T5 aluminum and the thickness is 1.2-2.0mm,
3. Width of wall profile and glass profile is 1", both adjustment can 2"
4. This style use SUS 304 stainless steel pulley racket. Material of pulley is black POM. Push and pull test arrived 150000 times. No drop and no break. It can ensure to use over 10 years of shower door
5. SUS 304 stainless steel anti-off spring roller, when clearing, you can make the lower pulley left under the aluminum, push the glass, more humane experience and use.
6. SUS 304 stainless steel bottom door guide can be pushed quietly and easily.



MODEL:2490

SIZE:L36"*W36"*H79"
L:35"~42"(900~1066mm)
W:35"~42"(900~1066mm)
H:72"~87"(1829~2200mm)
Thickness of glass: 1/4"(6mm)



MODEL:8490

SIZE:L40"*W40"*H79"
(1000*1000*2000mm)
L:32"~47"(800~1200mm)
W:32"~47"(800~1200mm)
H:72"~87"(1829~2200mm)
Thickness of glass:1/4"(6mm)

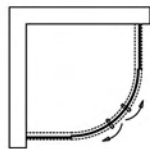

MODEL:290

SIZE: L48"* H79"(1200*2000mm)
L:47"~60"(1200~1600mm)
H:72"~87"(1829~2200mm)
Thickness of glass: 1/4" (6mm)

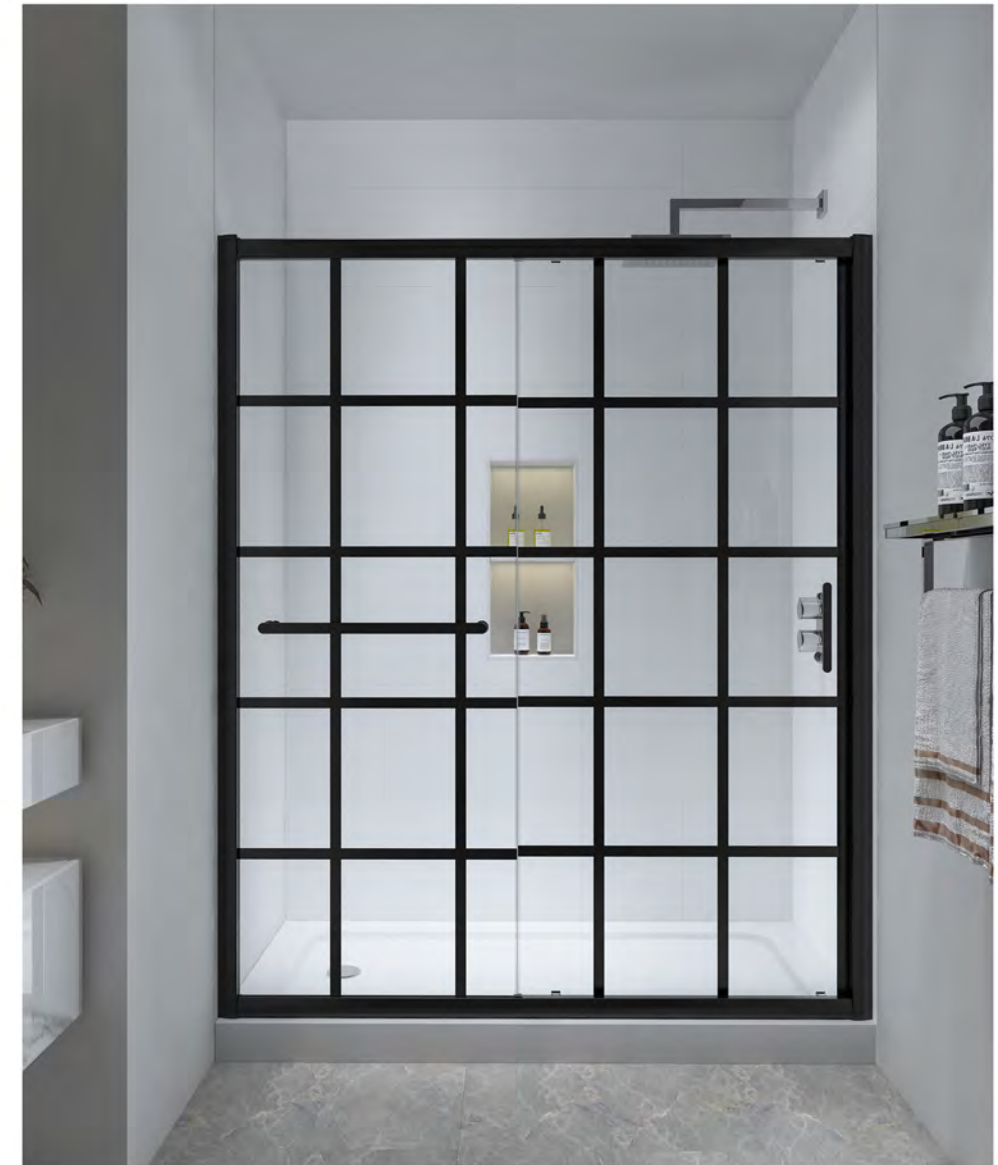
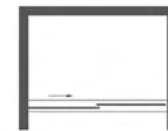

FEATURES

- Anti-jump system
- Max.72" width for an open and spacious feeling
- Stainless steel rollers create an effortless operation
- Rubber door stopper protects the glass door
- SGCC certified tempered glass,5/16"(8mm) & 3/8"(10mm)
- The anti-slash threshold in L shape to prevent water spills

Door Opening Direction

One sliding door opening either left or right

Adjustment

Wall mount bracket solution: no out-of-plumb adjustment

Glass Option

Clear, Frost, Easy-Cleaning

Finish

Bright chrome, brushed nickel, black and space gray



A	Design options	Diagram	B	Design options	Diagram
Standard	Top Rail		Standard	Handle	
Option	Wall Connect		Option	Roller	

SPECIFICATION

Dimensions In Imperial Units

Model	Finish wall to finish wall (L)	Approx. entry opening(O)	Height (H)
3320	46"-48"	21"	60" 76"
	52"-54"	24"	
	57"-60"	27"	
	62"-66"	30"	
	66"-72"	32"	
Glass: 5/16" or 3/8"		Return panel(W):32"-36"	

Dimensions In Metric Units

Model	Finish wall to finish wall (L)	Approx. entry opening(O)	Height (H)
3320	1150-1200mm	520mm	1500mm 2000mm
	1200-1300mm	558mm	
	1300-1400mm	608mm	
	1400-1500mm	658mm	
	1500-1600mm	708mm	
	1600-1800mm	783mm	
Glass: 8mm or 10mm		Return panel(W):800mm , 900mm , 1000mm	

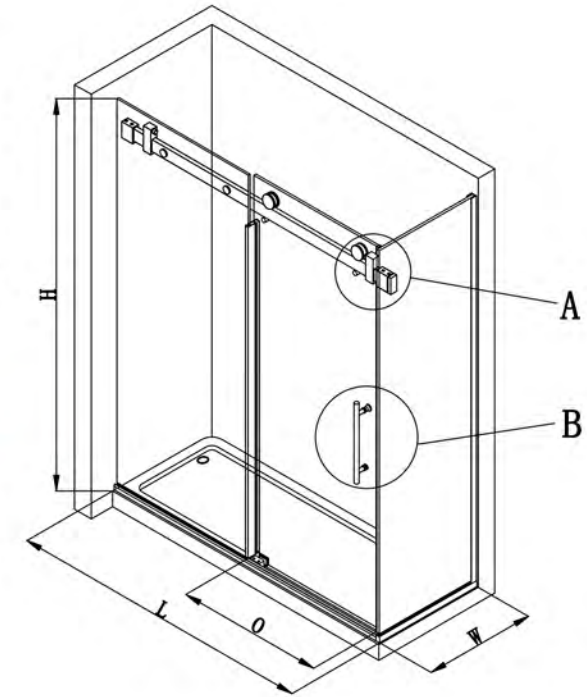

ADVANTAGE INTRODUCE

1. Tempered glass, which has past the American certification and can be clear or with decorative pattern. Thickness is 5/16" & 3/8"
2. Two durable SUS304 stainless steel pulleys with a diameter of $\Phi 40$ mm. Color can be bright chrome, brush nickle, black and space grey.
3. Square 30*10mm SUS304 stainless steel circular bar makes the door stronger and safer.
4. SUS304 stainless steel bottom door guide can be pushed quietly and easily
5. 5mm eccentric space of roller is adjustable
6. Fixed glass is placed within the bottom rail to prevent leakage of water.



MODEL:3320

SIZE:L48"* W32"* H79"

(1219*813*2000mm)

L:47"~60"(1200~1600mm)

W:32"~47"(800~1200mm)

H:72"~87"(1829~2200mm)

Thickness of glass: 5/16"(8mm) & 3/8" (10mm)

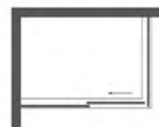

20 Series



MODEL:3320-1
SIZE:L60"* W36"* H79"(1524*914*2000mm)
L:47"~60"(1200~1600mm)
W:32"~47"(800~1200mm)
H:72"~87"(1829~2200mm)
Thickness of glass: 5/16"(8mm) & 3/8" (10mm)

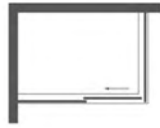



MODEL:220

SIZE:L60"* H79"(1524*2000mm)

L: 47"~60"(1200~1600mm)

H:72"~87"(1829~2200mm)

Thickness of glass: 5/16" (8mm)
3/8" (10mm)



MODEL:220A

SIZE:L60"* H60"(1524*1524mm)

L: 47"~60"(1200~1600mm)

H: 59"~60"(1500~1600mm)

Thickness of glass: 5/16" (8mm)
3/8" (10mm)

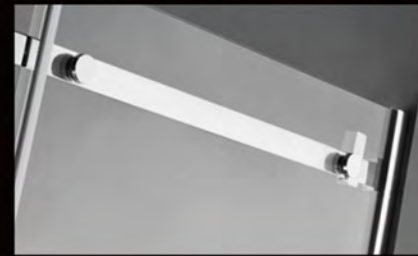

ADVANTGE INTRODUCE

- 1.High quality 5/16"+3/8"thickness tempered glass, which has passed the American certification can be clear or with decorative pattern
- 2.Ovak circular bar, SUS 304 stainless steel handle ,durable and safe.
- 3.Two SUS 304 stainless steel rollers with a diameter of Φ55mm and SUS 304 stainless steel top bar, handle and bottom guide.
- 4.Soft closing system

MODEL:A228

SIZE:L60"*H79" (1524*2000mm)
 L:47"~60"(1200~1600mm)
 H:72"~87"(1829~2200mm)
 Thickness of glass:5/16"(8mm)
 3/8"(10mm)



MODEL:A3328

SIZE:L60"*H79" (1524*2000mm)
 L:47"~60"(1200~1600mm)
 w:32"~36"(813~914mm)
 H:72"~87"(1829~2200mm)
 Thickness of glass:5/16"(8mm)
 3/8"(10mm)

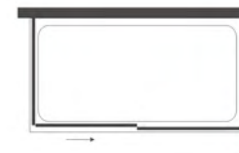

ADVANTAGE INTRODUCE

1. High quality 3/8" thickness tempered glass, which has passed the American certification can be clear or with decorative pattern.
2. Round circular bar with a diameter of $\Phi 25\text{mm}$, SUS304 stainless steel handle, durable and safe.
3. Two durable SUS 304 stainless steel rollers with a diameter of $\Phi 55\text{mm}$ and standard configuration of SUS304 stainless steel bearings. Color can be bright chrome, brush nickle ,black and space grey.
4. The direction of opening can be changed from left or right side.
5. SUS 304 stainless steel bottom door guide can be pushed quietly and easily.
6. Fixed glass is placed within the bottom rail to prevent leakage of water.

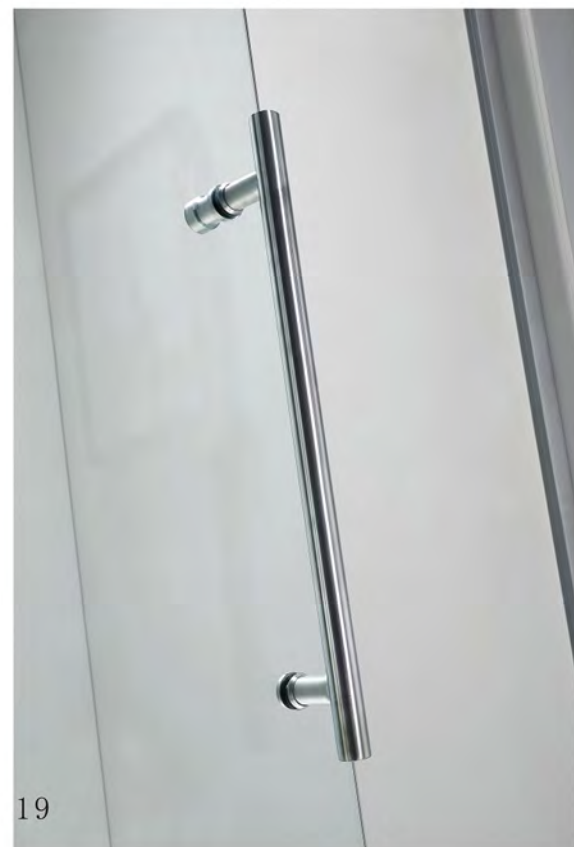

MODEL:283

SIZE:L48"* H79"(1220*2000mm)

L:47"~60"(1200~1600mm)

H:72"~87"(1829~2200mm)

Thickness of glass: 3/8"(10mm)





SUS 304 ϕ 55mm



MODEL:283-1

SIZE:L60"* H79"(1524*2000mm)

L:47"~60"(1200~1600mm)

H:72"~87"(1829~2200mm)

Thickness of glass: 3/8"(10mm)



MODEL:3383

SIZE:L60"* W36"* H79"(1524*914*2000mm)

L:47"~60"(1200~1600mm)

W:32"~47"(800~1200mm)

H:72"~87"(1829~2200mm)

Thickness of glass: 3/8"(10mm)

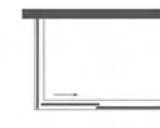

MODEL:283A

SIZE:L60"* H60"(1524*1524mm)

L:47"~60"(1200~1600mm)

H:59"~60"(1500~1600mm)

Thickness of glass: 3/8"(10mm)

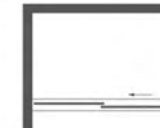

ADVANTAGE INTRODUCE

1. High quality 3/8" thickness tempered glass, which has passed the American certification can be clear or with decorative pattern.
2. Round 30*10mm SUS304 stainless steel circular bar makes the door stronger and safer.
3. Two SUS 304 stainless steel rollers with a diameter of $\Phi 55\text{mm}$ and standard configuration of 304 stainless steel bearings, will be durable without rust. Color can be bright chrome, brush nickle, black and grey.
4. The direction of opening can be changed from left or right side.
5. SUS 304 stainless steel bottom door guide can be pushed quietly and easily.
6. Fixed glass is placed within the bottom rail to prevent leakage of water.

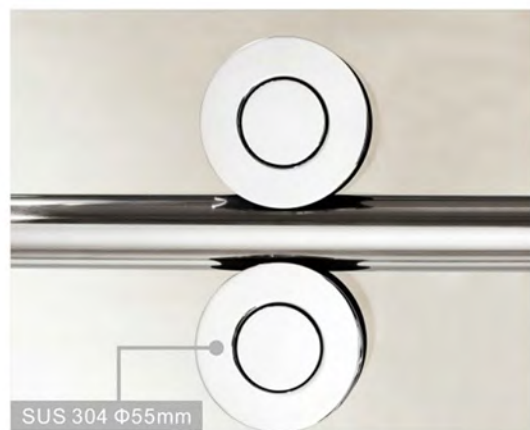

MODEL:284-1

SIZE:L60"* H79"(1524*2000mm)

L:47"~60"(1200~1600mm)

H:72"~87"(1829~2200mm)

Thickness of glass: 3/8"(10mm)



84 Series



MODEL:284A

SIZE:L60"* H60"(1524*1524mm)
L:47"~60"(1200~1600mm)
H:59"~60"(1500~1600mm)
Thickness of glass: 3/8"(10mm)

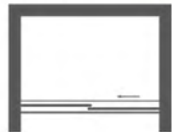

MODEL:3384

SIZE:L60"* W36"* H79"
(1524*914*2000mm)
L:47"~60"(1200~1600mm)
W:32"~47"(800~1200mm)
H:72"~87"(1829~2200mm)
Thickness of glass: 3/8"(10mm)

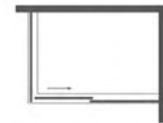

ADVANTAGE INTRODUCE

- 1. High quality 3/8" thickness tempered glass, which has passed the American certification can be clear or with decorative pattern.
- 2. Round circular bar with a diameter of $\Phi 25\text{mm}$, 304 stainless steel handle, durable and safe
- 3. Four SUS304 stainless steel rollers with a diameter of $\Phi 70\text{mm}$ and standard configuration of 304 stainless steel bearings, will be durable without rust. Color can be bright chrome, brush nickle ,black and grey.
- 4. The direction of opening can be changed from left or right side.
- 5. SUS 304 stainless steel bottom door guide can be pushed quietly and easily.
- 6. Fixed glass is placed within the bottom rail to prevent leakage of water.

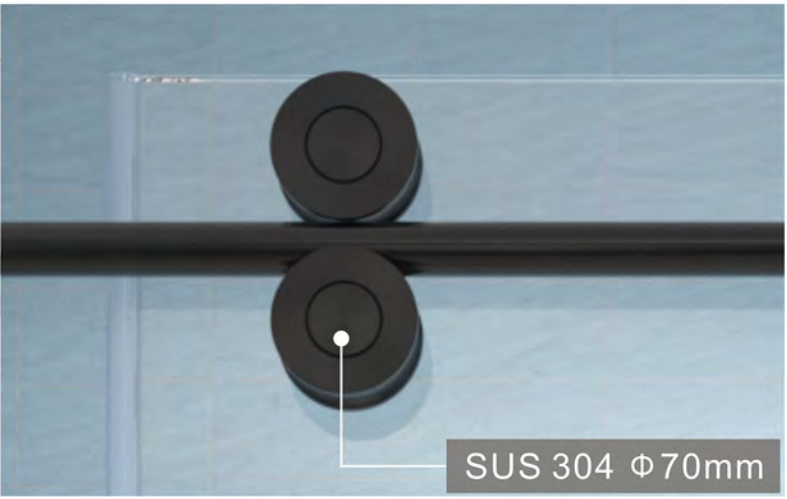

MODEL:228B-1

SIZE:L60"* H79"(1524*2000mm)
L:47"~60"(1200~1600mm)
H:72"~87"(1829~2200mm)
Thickness of glass: 3/8"(10mm)

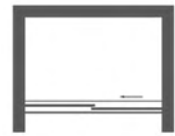

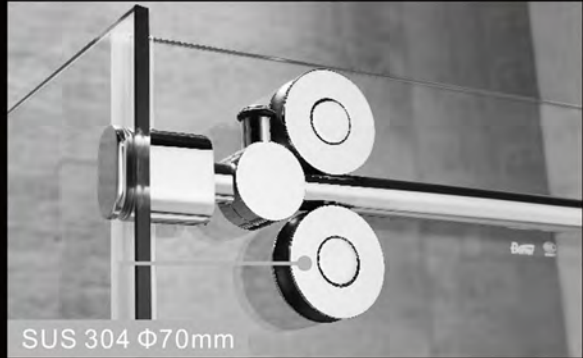

MODEL:3328B

SIZE:L60"* W36"* H79"(1524*914*2000mm)
L:47"~60"(1200~1600mm)
W:32"~47"(800~1200mm)
H:72"~87"(1829~2200mm)
Thickness of glass: 3/8"(10mm)



MODEL:228B

SIZE:L48"* H79"(1220*2000mm)
L:47"~60"(1200~1600mm)
H:72"~87"(1829~2200mm)
Thickness of glass: 3/8"(10mm)



ADVANTAGE INTRODUCE

1. High quality 3/8" thickness tempered glass, which has passed the American certification can be clear or with decorative pattern.
2. Round circular bar with a diameter of Φ 25mm, SUS304 stainless steel handle, durable and safe.
3. Two SUS304 stainless steel rollers with a diameter of Φ 70mm and standard configuration of 304 stainless steel bearings, will be durable without rust. Color can be bright chrome, brush nickle and black.
4. The direction of opening can be changed from left or right side.
5. SUS 304 stainless steel bottom door guide can be pushed quietly and easily
6. Fixed glass is placed within the bottom rail to prevent leakage of water.



MODEL:221-1

SIZE:L60"* H79"(1524*2000mm)

L:47"~60"(1200~1600mm)

H:72"~87"(1829~2200mm)

Thickness of glass: 3/8"(10mm)





SUS 304 Φ 70mm



MODEL:221

SIZE:L48"* H79"(1220*2000mm)

L:47"~60"(1200~1600mm)

H:72"~87"(1829~2200mm)

Thickness of glass: 3/8"(10mm)

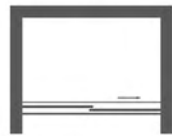

MODEL:3321

SIZE:L60"* W36"* H79"(1524*914*2000mm)

L:47"~60"(1200~1600mm)

W:32"~47"(800~1200mm)

H:72"~87"(1829~2200mm)

Thickness of glass: 3/8"(10mm)

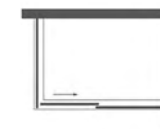

ADVANTAGE INTRODUCE

1. High quality 3/8" thickness tempered glass, which has passed the American certification can be clear or with decorative pattern.
2. Square 40*15mm circular bar, SUS304 stainless steel handle, strong and safe.
3. Two durable SUS 304 stainless steel rollers with a diameter of $\Phi 55\text{mm}$ and standard configuration of SUS 304 stainless steel bearings. Color can be bright chrome, brush nickle and black.
4. The direction of opening can be changed from left or right side.
5. SUS 304 stainless steel bottom door guide can be pushed quietly and easily.
6. Fixed glass is placed within the bottom rail to prevent leakage of water



MODEL:224H

SIZE:L60"* H79"(1524*2000mm)

L:47"~60"(1200~1600mm)

H:72"~87"(1829~2200mm)

Thickness of glass: 3/8"(10mm)



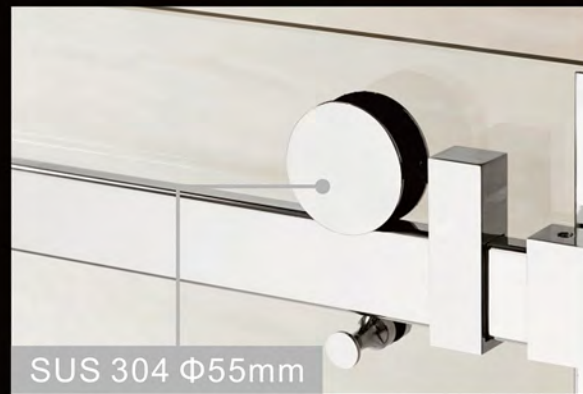

MODEL:224-1

SIZE:L60"* H79"(1524*2000mm)
 L:47"~60"(1200~1600mm)
 H:72"~87"(1829~2200mm)
 Thickness of glass: 3/8"(10mm)



MODEL:224

SIZE:L48"* H79"(1220*2000mm)
 L:47"~60"(1200~1600mm)
 H:72"~87"(1829~2200mm)
 Thickness of glass: 3/8"(10mm)





MODEL:3324

SIZE:L60"* W36"* H79"
(1524*914*2000mm)
L:47"~60"(1200~1600mm)
W:32"~47"(800~1200mm)
H:72"~87"(1829~2200mm)
Thickness of glass: 3/8"(10mm)



MODEL:224A

SIZE:L60"* H60"(1524*1524mm)
L:47"~60"(1200~1600mm)
H: 59"~60"(1500~1600mm)
Thickness of glass: 3/8"(10mm)



ADVANTAGE INTRODUCE

1. Tempered glass, which has past the American certification and can be clear or with decorative pattern. Thickness is 3/8"
2. Two SUS304 stainless steel rollers with a diameter of $\Phi 55\text{mm}$ and standard configuration of SUS 304 stainless steel bearings, will be durable without rust. Color can be bright chrome, brush nickle and black.
3. Round SUS304 stainless steel circular bar makes the shower door durable.
4. It can be installed upside down and the direction of opening can be changed from left or right side.
5. SUS 304 stainless steel bottom door guide can be pushed quietly and easily.
6. Fixed glass is placed within the bottom rail to prevent leakage of water.



MODEL:227-1

SIZE:L60"* H79"(1524*2000mm)

L:47"~60"(1200~1600mm)

H:72"~87"(1829~2200mm)

Thickness of glass: 3/8"(10mm)



27 Series



MODEL:227

SIZE:L48"* H79"(1219*2000mm)

L:47"~60"(1200~1600mm)

H:72"~87"(1829~2200mm)

Thickness of glass: 3/8"(10mm)



MODEL:227A

SIZE: L60"* H60"(1524*1524mm)

L:47"~60"(1200~1600mm)

H:59"~60"(1500~1600mm)

Thickness of glass: 3/8"(10mm)



27 Series



MODEL:3327

SIZE:L60"* W36"* H79"
(1524*914*2000mm)

L: 47"~60"(1200~1600mm)

W: 32"~47"(800~1200mm)

H:72"~87"(1829~2200mm)

Thickness of glass: 3/8"(10mm)



ADVANTAGE INTRODUCE

1. High quality 1/4" thickness tempered glass, which has passed the American certification can be clear or with decorative pattern.
2. It adopts 6463-T5 aluminum and the thickness is 1.2-2.0mm,
3. Width of wall profile and glass profile is 1", both adjustment can 2"
4. This style use SUS 304 stainless steel pulley racket. Material of pulley is black POM. Push and pull test arrived 150000 times. No drop and no break. It can ensure to use over 10 years of shower door
5. SUS 304 stainless steel anti-off spring roller, when clearing, you can make the lower pulley left under the aluminum, push the glass, more humane experience and use.
6. SUS 304 stainless steel bottom door guide can be pushed quietly and easily.

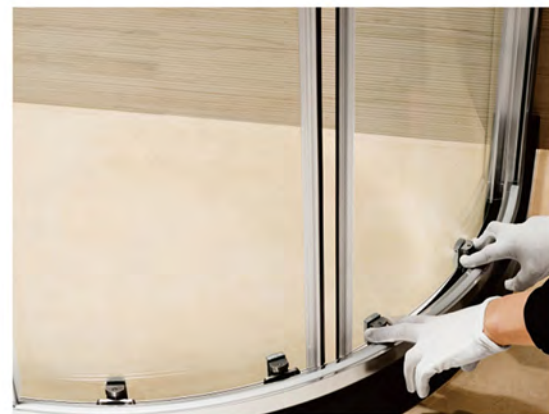

MODEL:8489

SIZE:L40"* W40"* H79"(1000*1000*2000mm)

L:32"~47"(800~1200mm)

W:32"~47"(800~1200mm)

H:72"~87"(1829~2200mm)

Thickness of glass: 1/4" (6mm)





MODEL:289

SIZE: L48"* H79"(1200*2000mm)
L:47"~60"(1200~1600mm)
H:72"~87"(1829~2200mm)
Thickness of glass: 1/4" (6mm)



MODEL:3389

SIZE: L48"* W32"* H79"(1200*800*2000mm)
L:47"~60"(1200~1600mm)
W:32"~47"(800~1200mm)
H:72"~87"(1829~2200mm)
Thickness of glass: 1/4" (6mm)



ADVANTAGE INTRODUCE

1. High quality 1/4" thickness tempered glass, which has passed the American certification can be clear or with decorative pattern.
2. It adopts 6463-T5 aluminum and the thickness is 1.1-1.5mm,
3. Pivot door can open outside 180 degrees and inside 180 degrees
4. Diameter of round SUS 304 stainless steel handle is $\Phi 16\text{mm}$
5. The profile against the wall can be adjusted to 20 mm to solve the problem of the wall tilt.



MODEL:236A

SIZE:L44"* H59"(1100*1500mm)

L:40"~48"(1000~1200mm)

H:59"~60"(1500~1600mm)

Thickness of glass: 1/4" (6mm)

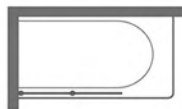

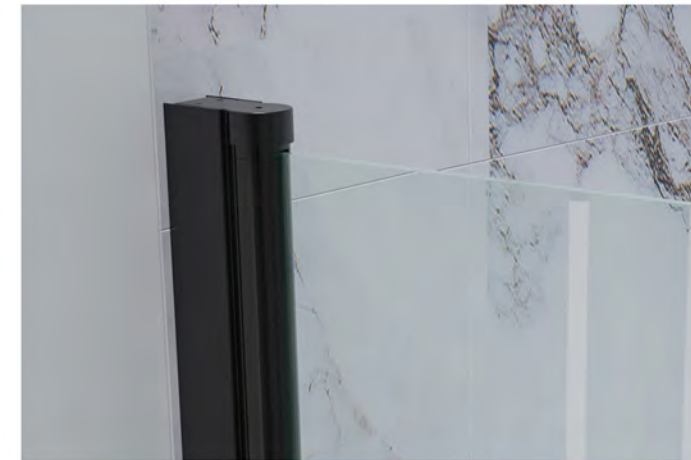

MODEL:136A

SIZE: L30"* H59" (750*1500mm)

L:24"~32"(600~800mm)

H:59"~60"(1500~1600mm)

Thickness of glass: 1/4" (6mm)



ADVANTAGE INTRODUCE

1. High quality tempered glass, which has passed the American certification can be clear or with decorative pattern.
2. The hinge material is made of SUS 304 stainless steel, salt spray test for 48 hours
3. The one hinge can load more than 40kg, better ensure the safety and durability of the products.
4. The wall hinge pressure plate has a reserved strip recess, the strip can extend into the hinge so that to reach a waterproof effect.
5. A flexible pull rod, the size can be adjusted according to the site installation.



MODEL:253

SIZE:L48"*H72"

L:47"~62"(1200~1600mm)

H:72"~87"(1829~2200mm)

Thickness of glass:3/8"(10mm)



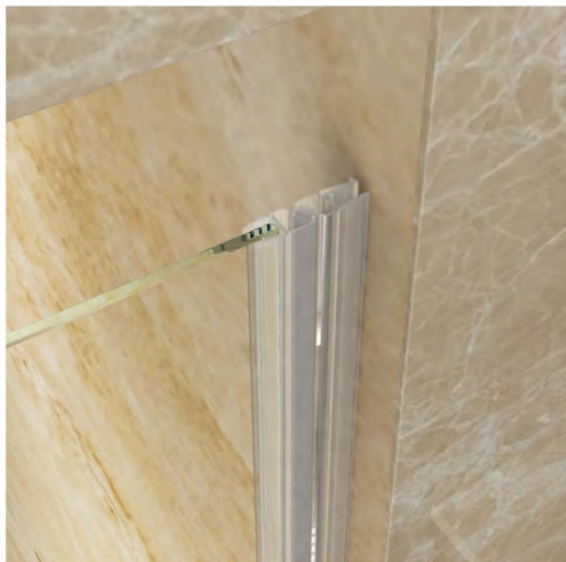

MODEL:153

SIZE:L29"*H72"

L:27"~36"(685~914mm)

H:72"~87"(1829~2200mm)

Thickness of glass:3/8"(10mm)



ADVANTAGE INTRODUCE

1. High quality 3/8" thickness tempered glass, which has passed the American certification can be clear or with decorative pattern.
2. Up and down spindles, handles and circular bar are made of SUS304 stainless steel to make the entire structure strong and durable.
3. Fixed glass is placed within the bottom rail to prevent leakage of water.
4. Handle is made of Square SUS 304 stainless steel, it very strong and durable
5. Wall profile can adjust 10mm, it can solve due to the wall tilt caused by installation problems.

MODEL:6311

SIZE:L40"* W40"* H79"(1000*1000*2000mm)

L:32"~47"(800~1200mm)

W:32"~47"(800~1200mm)

H:72"~87"(1829~2200mm)

Thickness of glass: 3/8"(10mm)

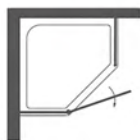



MODEL:311

SIZE: L59"* H79"(1500*2000mmmm)

L:47"~79"(1200~2000mm)

H:72"~87"(1829~2200mm)

Thickness of glass: 3/8"(10mm)

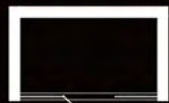

MODEL:3311

SIZE: L52"* W36"* H79"(1300*900*2000mm)

L:47"~60"(1200~1600mm)

W:32"~47"(800~1200mm)

H:72"~87"(1829~2200mm)

Thickness of glass: 3/8"(10mm)



18 Series

ADVANTAGE INTRODUCE

- 1.High quality tempered glass, which has passed the American certification can be clear or with decorative pattern.
- 2.The hinge material is made of SUS 304 stainless steel, salt spray test for 48 hours
- 3.The one hinge can load more than 40kg, better ensure the safety and durability of the products.
- 4.The wall hinge pressure plate has a reserved strip recess, the strip can extend into the hinge so that to reach a waterproof effect.
- 5.A flexible pull rod, the size can be adjusted according to the site installation.
- 6.Color can be bright chrome, PVD gold and black.



MODEL:118

SIZE:L36"* H79"(900*2000mm)

L: 28"~36"(700~900mm)

H: 72"~87"(1829~2200mm)

Thickness of glass: 3/8" (10mm)

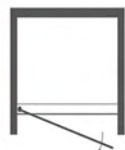

18 Series



MODEL:218

SIZE:L60"* H79"(1524*2000mm)

L:47"~60"(1200~1600mm)

H:72"~87"(1829~2200mm)

Thickness of glass: 3/8"(10mm)



MODEL:318

SIZE: L59"* H79"(1500*2000mm)

L:47"~60"(1200~2000mm)

H:72"~87"(1829~2200mm)

Thickness of glass: 3/8"(10mm)



18 Series



MODEL:6318

SIZE:L40"* W40"* H79"(1000*1000*2000mm)

L:32"~47"(800~1200mm)

W:32"~47"(800~1200mm)

H:72"~87"(1829~2200mm)

Thickness of glass:3/8" (10mm)



MODEL:3318

SIZE:L48"* W36"* H79"(1200*800*2000mm)

L:47"~60"(1200~1600mm)

W:32"~47"(800~1200mm)

H:72"~87"(1829~2200mm)

Thickness of glass:3/8" (10mm)





MODEL:118A

SIZE:L34"*H58"
 L:30"~36"(762~914mm)
 H:58"~62"(1473~1574mm)
 Thickness of glass:1/4"(6mm)

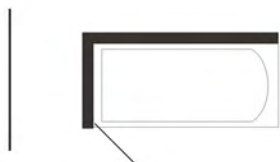

MODEL:218A

SIZE:L48"*H58"
 L:48"~60"(1219~1524mm)
 H:58"~62"(1473~1574mm)
 Thickness of glass:1/4"(6mm)



93 Series

ADVANTAGE INTRODUCE

1. High quality 3/8" thickness tempered glass, which has passed the American certification can be clear or with decorative pattern.
2. It adopts 6463-T5 aluminum state and the thickness is between 1.1-1.5mm
3. Bottom rail structural let the glass more stable and safe.
4. The profile against the wall can be adjusted to 10mm to solve the problem of the wall tilt.



MODEL: 7193-1

L: 28"~48" (700~1200mm)
H: 72"~87" (1829~2200mm)
Thickness of glass: 3/8" (10mm)

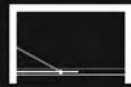

MODEL: 7193

L: 28"~48" (700~1200mm)
H: 72"~87" (1829~2200mm)
Thickness of glass: 3/8" (10mm)

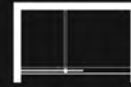

95 Series

ADVANTAGE INTRODUCE

1. High quality 5/16" thickness tempered glass, which has passed the American certification can be clear or with decorative pattern.
2. It adopts 6463-T5 aluminum and the thickness is 1.8-3.0mm,
3. Double sliding design and center-guided door system improve the convenience of cleaning
4. Diameter of round SUS 304 stainless steel handle is $\Phi 19\text{mm}$
5. Four rollers, push - pull is very easy and quiet. Standard configuration of SUS 304 stainless steel bearings will be durable without rust
6. Double-sided push-pull can be easy to use or clean.

MODEL: 295

SIZE: L60"* H79" (1524*2000mm)
L: 47"~60" (1200~1524mm)
H: 72"~87" (1829~2200mm)
Thickness of glass: 5/16" (8 mm)

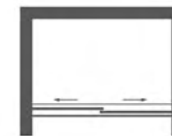

ADVANTAGE INTRODUCE

1. High quality 3/8" thickness tempered glass, which has passed the American certification can be clear or with decorative pattern.
2. SUS 304 stainless steel frame.
3. Color can be bright chrome and black.

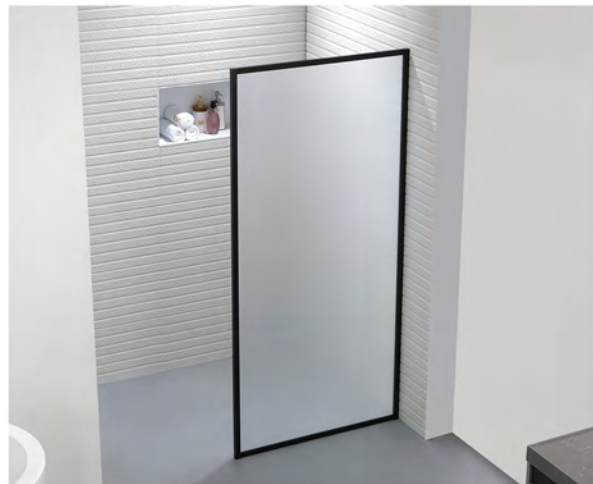

MODEL:102

SIZE:L36"* H79"(900*2000mm)

L: 28"~36"(700~900mm)

H:72"~87"(1829~2200mm)

Thickness of glass: 3/8" (10mm)



ADVANTAGE INTRODUCE

5/16inch (8mm).SGCC&ANSI Certified Clear Tempered Safety Glass. SUS 304 Stainless Steel Hardware.
Hardware finish: Available in Chrome , Brushed Nickel , Black, Gray and Rose Gold.
Both sliding door opening with 4 wheels effortless sliding action
Stainless steel top track and bottom track can be trimmed up to 4 inch for width adjustment
This model has adjustment for out-of-plum(uneven walls), adjust the wheel.
Important all measurements should be taken only after walls are finished
Professional installation is required 2 person team necessary
5 years warranty on all hardware parts

MODEL:296

SIZE: L60"* H79"(1524*2000mm)
L:47"~60"(1200~1600mm)
H:72"~87"(1829~2200mm)
Thickness of glass: 5/16" (8mm)

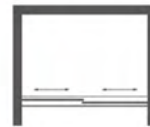

MODEL: A201

SIZE:L60"* H79"(1524*2000mm)
L: 47"~60"(1200~1524mm)
H:72"~87"(1829~2200mm)
Thickness of glass:6/15"(8 mm)



ADVANTAGE INTRODUCE

1. Tempered glass, which has passed the American certification, can be clear or frosted, thickness is 3/8".
2. Two big pulley assembly, sus304 stainless steel finish, color can be bright chrome, brush nickel, or black.

MODEL: A115

SIZE: L36" * H79" (900*2000mm)
L: 28" ~ 36" (700~900mm)
H: 72" ~ 87" (1829~2200mm)
Thickness of glass: 3/8" (10mm)



ADVANTAGE INTRODUCE

1. Bright chrome sus304 stainless steel clear tempered glass.
2. Double sliding design, Centerguided boor system for smooth, quiet sliding and improved easy of cleaning.
3. Gently curved inside and outside towel bar handles, sus304 stainless steel finished.
4. Water tight seals prevent leakage.

MODEL:292

SIZE:L48"* H79"(1200*2000mm)
L: 47"~60"(1200~1600m)
H:72"~87"(1829~2200mm)
Thickness of glass: 5/16" (8mm)

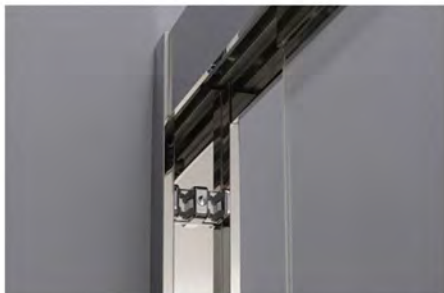
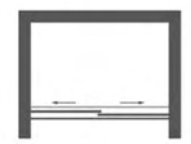

MODEL:3392

SIZE:L36"*W36"H79"
L:35"~42"(900~1066mm)
W:35"~42"(900~1066mm)
H:72"~87"(1829~2200mm)
Thickness of glass:5/16"(8mm)



ADVANTAGE INTRODUCE

1. High quality 5/16" thickness tempered glass, which has passed the American certification can be clear or with decorative pattern.
2. It adopts 6463-T5 aluminum and the thickness is 1.8-3.0mm,
3. Double sliding design and center-guided door system improve the convenience of cleaning
4. Size of square SUS 304 stainless steel handle is 32*16mm
5. Four pulleys, push - pull is very easy and quiet. Standard configuration of SUS 304 stainless steel bearings will be durable without rust
6. Two sliding door, it very convenient of use and clean.
7. Hanging round of hardware, you can after the installation is complete, and then adjust the level of glass, you can adjust 5mm;



MODEL:297

SIZE:L60"*H79" (1524*2000mm)
L:47"~60"(1200~1600mm)
H:72"~87"(1829~2200mm)
Thickness of glass:5/16"(8mm)

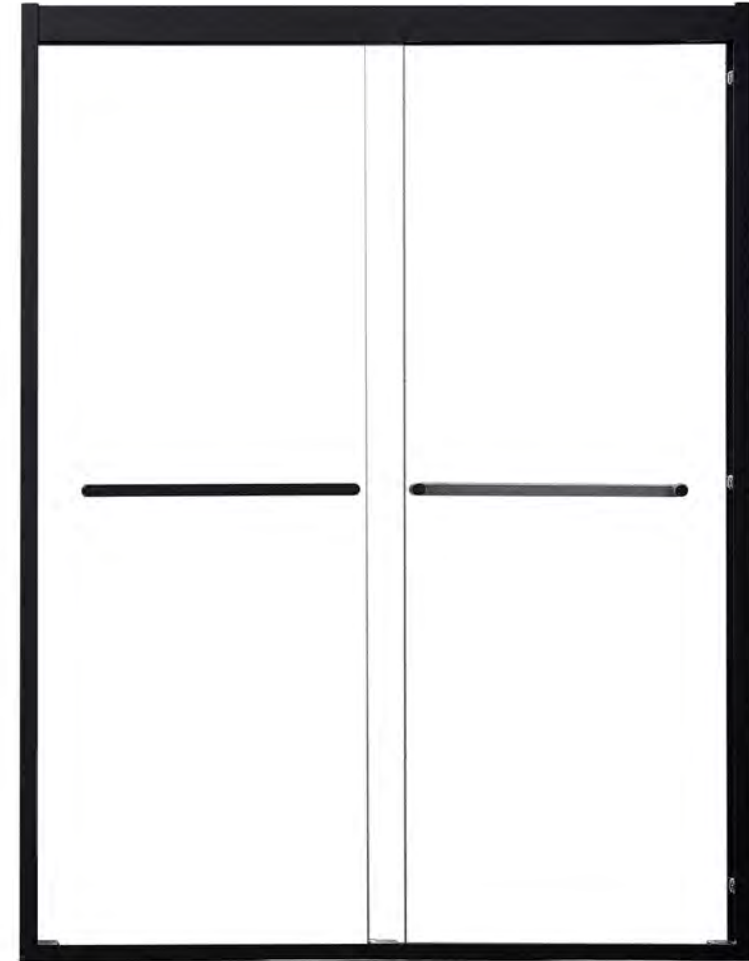
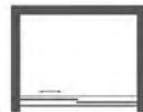

ADVANTGE INTRODUCE

- 1.High quality 5/16"thickness SGCC certified tempered glass. Clear, Frost, Easy-Cleaning
- 2.Soft closing system.
- 3.It adopts 6463-T4 aluminum and the thickness is 1.8-3.0mm
- 4.Double sliding design and center-guide door system improve the convenience of cleaning.

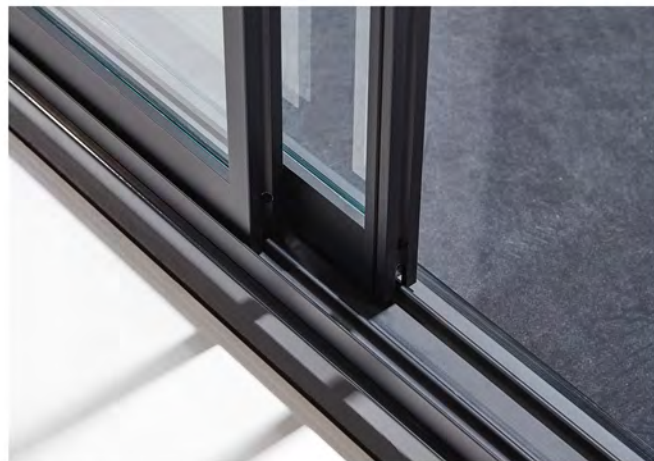

MODEL:298

SIZE:L60"*H79" (1524*2000mm)

L:47"~60"(1200~1600mm)

H:72"~87"(1829~2200mm)

Thickness of glass:5/16"(8mm)

